

PL-8800

ULTRASONIC - Parking Sensor

OWNER'S MANUAL

CONTENTS:

OPERATING INSTRUCTIONS
DESCRIPTION OF FUNCTIONS AND FEATURES
WIRE CONNECTION GUIDE
INSTALLATION GUIDE

Before operating this set, please read these instructions completely.

Installation

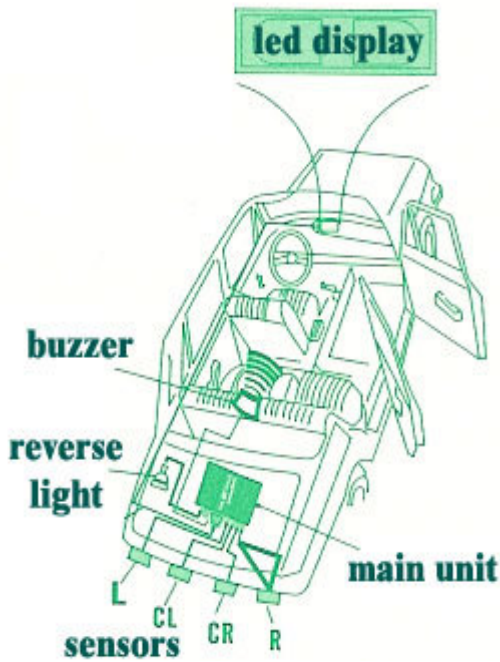

Sensors Distance

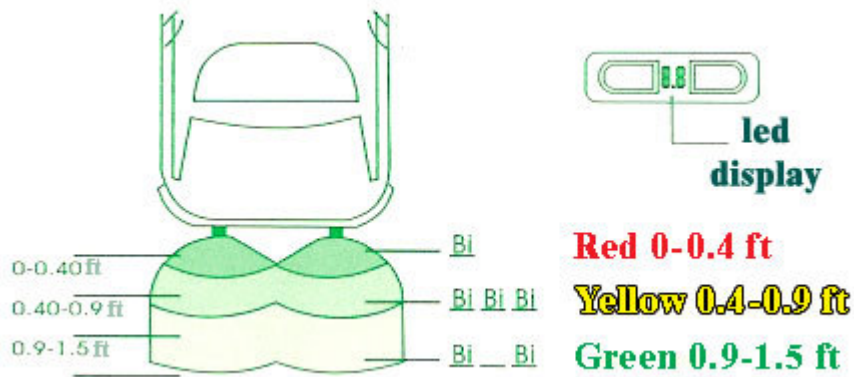

Install Distance

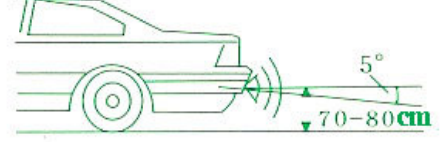
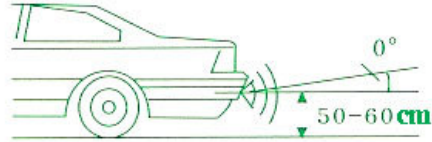
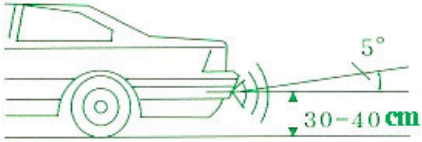
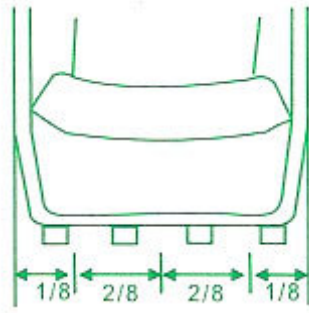

Sensors Location

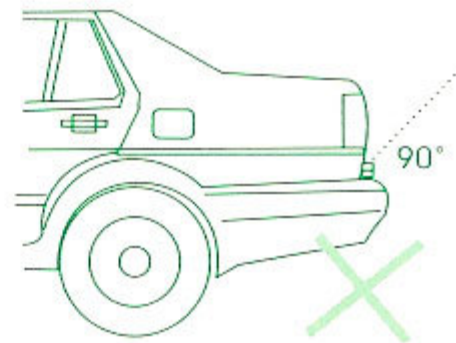
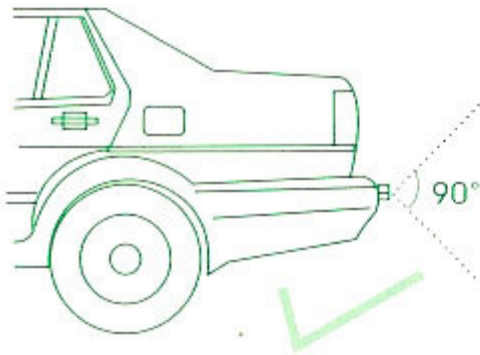
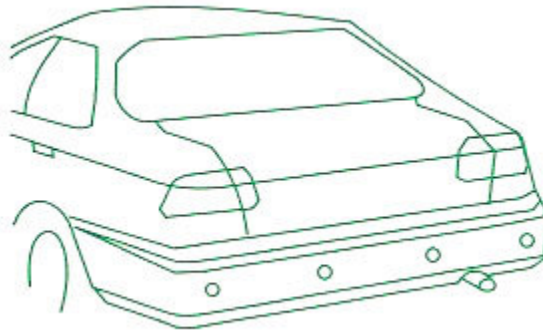
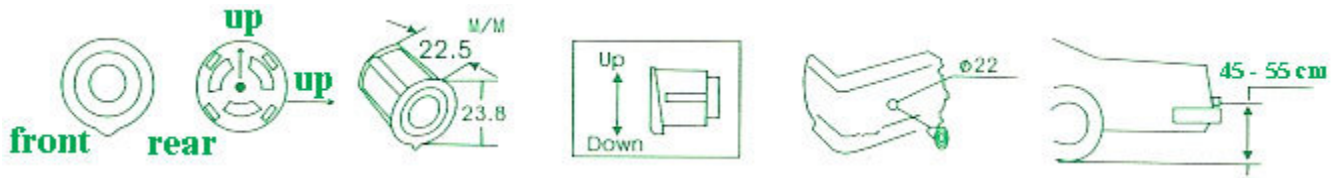

UNABLE DETECTED OBJECTS



Technological Specification

Voltage:	DC +12v
Current:	40 mA
Detect Distance:	2 – 150 cm
Detect Angle:	H > 100 deg > 50 deg
Temperature:	-20c to +65c

Should any problem persists, please contact your dealer, installer, and technician.

- Thanks for purchasing elfinx products -